



Operator's Manual

THE POWER WITHIN™



Model 290000 | Vanguard

Model 350000 | Vanguard

Model 300000 | Vanguard

Model 380000 | Vanguard

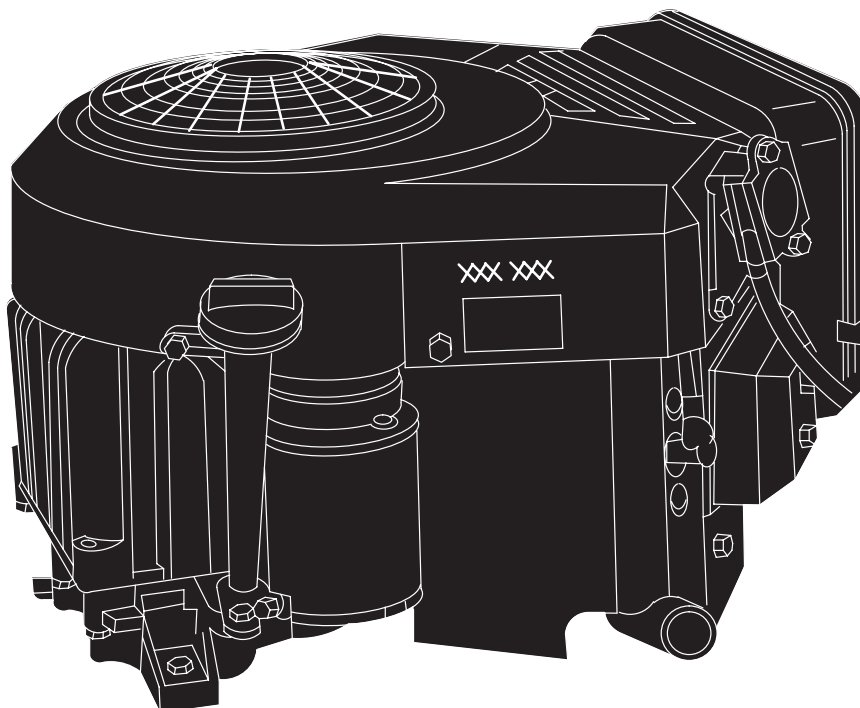

Safety References

The safety alert symbol  is used to identify safety information about hazards that can result in personal injury. A signal word (DANGER, WARNING, or CAUTION) is used with the alert symbol to indicate the likelihood and the potential severity of injury. In addition, a hazard symbol may be used to represent the type of hazard.

 **DANGER** indicates a hazard which, if not avoided, **will result in death or serious injury.**

 **WARNING** indicates a hazard which, if not avoided, **could result in death or serious injury.**

 **CAUTION** indicates a hazard which, if not avoided, **might result in minor or moderate injury.**

CAUTION, when used **without** the alert symbol, indicates a situation that **could result in damage to the engine.**





















  This manual contains safety information to make you aware of the hazards and risks associated with engines, and how to avoid them. Because Briggs & Stratton does not necessarily know what equipment this engine will power, it is important that you read and understand these instructions and the instructions for the equipment this engine powers.

Table of Contents

Safety References	2
Features	3
Safety	4-5
Oil	6
Fuel	7
Starting	8
Stopping	9
Troubleshooting	10
Maintenance	11-14
Specifications and Emission Information	15
Storage and Service	16
Warranty Information	17

SYMBOLS ASSOCIATED WITH THIS ENGINE:

	Fire		Read Manual
	Explosion		Oil
	Kickback		Fuel
	Hot Surface		Fuel Shutoff
	Toxic Fumes		On Off
	Moving Parts		Choke
	Shock		Stop
	Wear Eye Protection		Slow
	Frostbite		Fast

WARNING

Briggs & Stratton does not approve or authorize the use of these engines on 3-wheel All Terrain Vehicles (ATVs), motor bikes, fun/recreational go-karts, aircraft products or vehicles intended for use in competitive events. Use of these engines in such applications could result in property damage, serious injury (including paralysis), or even death.

WARNING

The engine exhaust from this product contains chemicals known to the State of California to cause cancer, birth defects, or other reproductive harm.

CAUTION



This engine is shipped from Briggs & Stratton without oil. If you start the engine without oil, the engine will be damaged beyond repair and will not be covered under warranty.

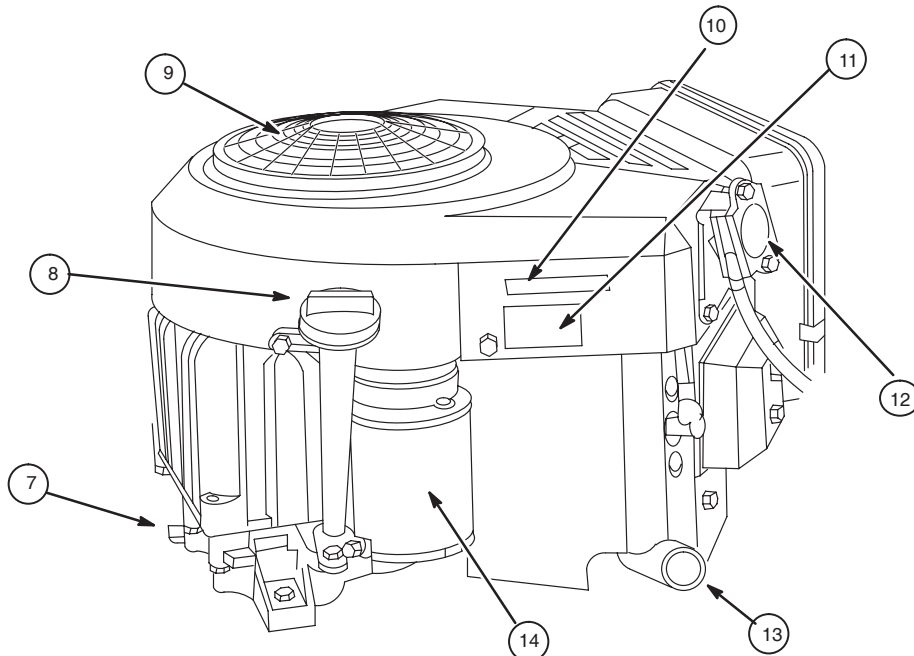
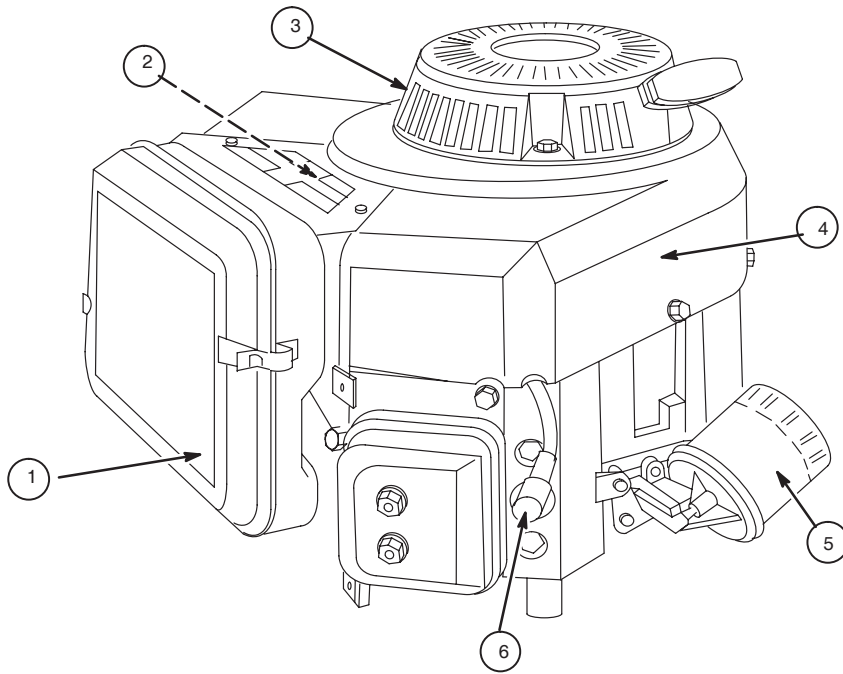

Features



1. Air Cleaner
2. Carburetor or LPG / NG Fuel Mixer
3. Rewind Starter (if equipped)
4. Blower Housing
5. Oil Filter (if equipped)
6. Spark Plug Wire
7. Oil Drain Plug
8. Oil Fill/Dipstick
9. Rotating Screen
10. Emission Label
11. Engine Identification
- Model XXXXXX Type XXXXXX Code
XXXXXXXX**
12. Fuel Pump
13. Exhaust Manifold
14. 12V Electric Starter (if equipped)



Safety

 	<p> WARNING</p> <p>Gasoline and its vapors are extremely flammable and explosive. Fire or explosion can cause severe burns or death.</p> <p>WHEN ADDING FUEL</p> <ul style="list-style-type: none">• Turn engine OFF and let engine cool at least 2 minutes before removing gas cap.• Fill fuel tank outdoors or in well-ventilated area.• Do not overfill fuel tank.• Keep gasoline away from sparks, open flames, pilot lights, heat, and other ignition sources.• Check fuel lines, tank, cap, and fittings frequently for cracks or leaks. Replace if necessary. <p>WHEN STARTING ENGINE</p> <ul style="list-style-type: none">• Make sure spark plug, muffler, fuel cap and air cleaner are in place.• Do not crank engine with spark plug removed.• If fuel spills, wait until it evaporates before starting engine.• If engine floods, set choke to OPEN/RUN position, place throttle in FAST and crank until engine starts. <p>WHEN OPERATING EQUIPMENT</p> <ul style="list-style-type: none">• Do not choke carburetor to stop engine. <p>WHEN TRANSPORTING EQUIPMENT</p> <ul style="list-style-type: none">• Transport with fuel tank EMPTY. <p>WHEN STORING GASOLINE OR EQUIPMENT WITH FUEL IN TANK</p> <ul style="list-style-type: none">• Store away from furnaces, stoves, water heaters or other appliances that have pilot light or other ignition source because they can ignite gasoline vapors.
--	--

 	<p> WARNING</p> <p>Starting engine creates sparking. Sparking can ignite nearby flammable gases. Explosion and fire could result.</p> <ul style="list-style-type: none">• If there is natural or LP gas leakage in area, do not start engine.• Do not use pressurized starting fluids because vapors are flammable.
--	---

 	<p> WARNING</p> <p>Gaseous fuels, such as liquid petroleum gas (LPG) and natural gas (NG), are extremely flammable and can readily form explosive air-vapor mixtures at moderate temperatures.</p> <p>IF YOU SMELL GAS:</p> <ul style="list-style-type: none">• DO NOT start the engine.• DO NOT actuate any electrical switches.• DO NOT use the phone in the vicinity.• Evacuate the area.• Contact the gas supplier or fire department. <p>REMEMBER:</p> <ul style="list-style-type: none">• LPG vapor is heavier than air and tends to collect in low areas. NG vapor is lighter than air and tends to collect in high areas. Both may travel to remote locations.• Keep all flames, sparks, pilot lights and other ignition sources away from the area where the engine is operated or repaired.• DO NOT smoke when operating or repairing the engine.• DO NOT store gasoline or other flammable vapors or liquids in the vicinity of the engine.• BEFORE doing any service work to the engine, shut off the gas supply.• After initial installation or servicing, check for gas leaks. DO NOT use an open flame. Apply very soapy water or leak test solution with a brush and look for bubbles.• Keep the equipment and the area surrounding the engine free of debris.• Install the fuel system according to applicable fuel/gas codes.
--	---



WARNING

Rapid retraction of starter cord (kickback) will pull hand and arm toward engine faster than you can let go.

Broken bones, fractures, bruises or sprains could result.

- When starting engine, pull cord slowly until resistance is felt, then pull rapidly.
- Direct coupled equipment components such as, but not limited to, blades, impellers, pulleys, sprockets, etc., must be securely attached.



WARNING

Rotating parts can contact or entangle hands, feet, hair, clothing, or accessories.

Traumatic amputation or severe laceration can result.

- Operate equipment with guards in place.
- Keep hands and feet away from rotating parts.
- Tie up long hair and remove jewelry.
- Do not wear loose-fitting clothing, dangling drawstrings or items that could become caught.



WARNING

Engines give off carbon monoxide, an odorless, colorless, poison gas. Breathing carbon monoxide can cause nausea, fainting or death.

- Start and run engine outdoors.
- Do not start or run engine in enclosed area, even if doors or windows are open.



WARNING

Running engines produce heat. Engine parts, especially muffler, become extremely hot.

Severe thermal burns can occur on contact.

Combustible debris, such as leaves, grass, brush, etc. can catch fire.



- Allow muffler, engine cylinder and fins to cool before touching.
- Remove accumulated debris from muffler area and cylinder area.
- Install and maintain in working order a spark arrester before using equipment on forest-covered, grass-covered, brush-covered unimproved land. The state of California requires this (Section 4442 of the California Public Resources Code). Other states may have similar laws. Federal laws apply on federal land.



WARNING

Unintentional sparking can result in fire or electric shock.

Fire or explosion can cause severe burns or death.

Unintentional start-up can result in entanglement, traumatic amputation, or laceration.



Before performing maintenance or repairs:

- Disconnect spark plug wire and keep it away from spark plug.
- Disconnect battery at negative terminal (only engines with electric start).
- Use only correct tools.
- Do not strike the flywheel with a hammer or hard object because the flywheel may later shatter during operation.
- Do not tamper with governor spring, links or other parts to increase engine speed.

When testing for spark:

- Use approved spark plug tester.
- Do not check for spark with spark plug removed.



WARNING

Wear eye protection when doing repair work.

Frostbite can result from skin/eye contact with leaking LP liquid.



- Installation, adjustment and repair work should be done by a qualified technician.
- Flexible supply lines should be checked regularly to make sure they are in good condition. Replace damaged or leaking components.

Before Starting

Oil

Oil Capacity

Engine holds approximately 1-1/2 quarts (48 ounces or 1.4 liters) when changing oil and filter.

Oil Recommendation

- Use a high quality detergent oil classified “For Service SF, SG, SH, SJ” or higher. Briggs & Stratton strongly recommends the use of synthetic oil. If synthetic oil is unavailable, Briggs & Stratton non-synthetic 30 weight oil P/N 1000005 (20 oz.) or P/N 1000028 (48 oz.) is an acceptable substitute.
- Do not use special additives.
- Choose a viscosity according to the table below.



Note: Synthetic oil meeting ILSAC GF-2, API certification mark and API service symbol (shown at left) with “SJ/CF ENERGY CONSERVING” or higher, is an acceptable oil at all temperatures. **Use of synthetic oil does not alter required oil change intervals.**

SAE Viscosity Grades	
←	→
5W-30, 10W-30	30
Synthetic 5W-30, 10W-30	
°F -20	100
°C -30	40
STARTING TEMPERATURE RANGE ANTICIPATED BEFORE NEXT OIL CHANGE	
CAUTION	
<p>* Air cooled engines run hotter than automotive engines. The use of non-synthetic multi-viscosity oils (5W-30, 10W-30, etc.) in temperatures above 40° F (4° C) will result in higher than normal oil consumption. When using a multi-viscosity oil, check oil level more frequently.</p> <p>** SAE 30 oil, if used below 40° F (4° C), will result in hard starting and possible engine bore damage due to inadequate lubrication.</p>	

Checking and Adding Oil

- Check oil level before starting the engine.
- Keep oil level at FULL. Do not overfill.
- Check level daily, or after every eight (8) hours.

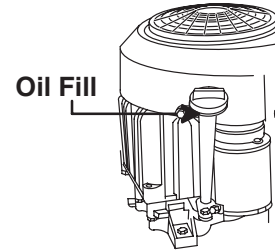

1. Place engine level and clean around oil fill and dipstick.
2. Remove dipstick and wipe with clean cloth.
3. Tighten dipstick down. Remove and check oil level.
4. Remove oil fill cap. Pour oil slowly. First add 1 qt (32 oz or 1 liter). Start and run engine at idle for 30 seconds. Shut off engine and wait 30 seconds. Then add more oil slowly to bring level to FULL mark on dipstick.

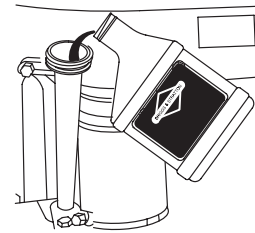

5. Fill to FULL mark on dipstick. Recheck.

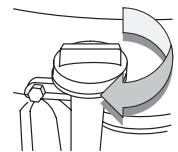
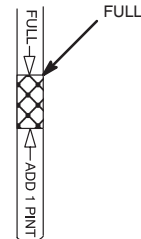

6. Tighten dipstick firmly.

Oil Pressure Switch

If engine is equipped with oil pressure switch, the switch will either activate a warning device or stop the engine when the engine runs low on oil. (Read the operating instructions supplied by equipment manufacturer to determine how your engine is equipped.)

Before Starting

Fuel

Gasoline Powered Engines

- Use clean, fresh, regular unleaded gasoline with a minimum of 85 octane. Fresh fuel prevents gum from forming in the fuel system or on essential carburetor parts. Purchase fuel in quantity that can be used within 30 days.
- For engine protection use Briggs & Stratton Gasoline Additive available from your Authorized Briggs & Stratton Dealer.
- Do not use gasoline which contains Methanol.
- Do not mix oil with gasoline.
- This engine is certified to operate on gasoline. Exhaust Emission Control System: EM (Engine Modifications).

Adding Fuel

1. Turn engine OFF and let engine cool at least 2 minutes before removing gas cap.
2. Remove cap. Fill tank to approximately 1-1/2 inches below top of neck to allow for fuel expansion. Be careful not to overfill.
3. Replace cap before starting.

CAUTION

Some fuels, called oxygenated or reformulated fuels, are fuels blended with alcohols or ethers. Excessive amounts of these blends can damage the fuel system or cause performance problems. If any undesirable operating symptoms occur, use gasoline with a lower percentage of alcohol or ether.

Liquid Propane Gas (LPG)

Natural Gas (NG) Powered Engines

- Use clean, dry fuel, free of moisture or any particulate material. Using fuels outside the following recommended values may cause performance problems.
- In engines set to run on LPG, commercial grade HD5 LPG is recommended. Recommended fuel composition is fuel with a minimum fuel energy of 2500 BTU's/ft³ with maximum propylene content of 5% and butane and heavier gas content of 2.5% and minimum propane content of 90%.
- LPG or NG engines are certified to operate on liquid propane gas or natural gas.

Adding Fuel

Read the operating instructions supplied by the equipment manufacturer for information on refueling natural or LP gas engine.

WARNING



LPG/NG Engines: The equipment on which this engine is mounted is equipped with an automatic safety gas "fuel lock-off" valve. DO NOT operate the equipment if the "fuel lock-off" valve is missing or inoperative.

Starting Oil Pressure Switch

If engine is equipped with oil pressure switch, the switch will either activate a warning device or stop the engine when the engine runs low on oil. (Read the operating instructions supplied by equipment manufacturer to determine how your engine is equipped.)

Before Starting - Liquid Petroleum Gas (LPG) / Natural Gas (NG) Engines

The LPG/NG mixer is equipped with solenoid, fuel inlet, 12 volt connector, and equipped for a fuel lock-off valve. (Read the operating instructions supplied by equipment manufacturer to determine how your engine is equipped.)

CAUTION

The manufacturer of the equipment on which this engine is installed specifies top speed at which the engine will be operated. **DO NOT EXCEED** this speed.

CAUTION
When operating on LPG fuel, 12 volts MUST be supplied to the connector. When operating on NG fuel, 12 volts MUST NOT be supplied to connector. Failure to do so may cause engine damage.

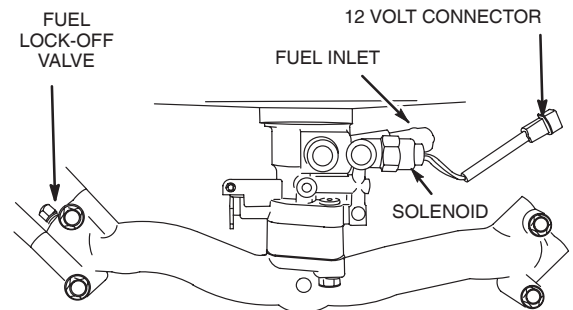

Starting – All Engines

1. Check oil level.

Note: LPG/NG Engines: Skip steps 2 and 3.

2. Open fuel shut-off valve (if equipped).
3. Pull choke control to CHOKE or START position.

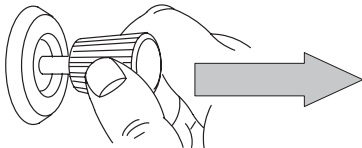

4. Move throttle (if equipped) to FAST position. Operate engine with throttle in FAST position and choke in RUN or OFF position.

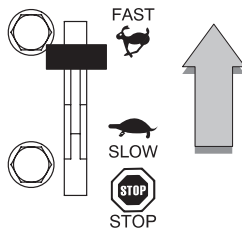

5. **REWIND (MANUAL) STARTER:** Grasp rope handle. Pull slowly until resistance is felt. Then pull rapidly to start engine and avoid kickback. Repeat if necessary with choke in OFF or RUN.

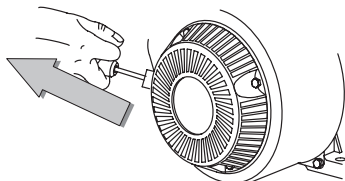

6. **ELECTRIC (KEY) STARTER:** Push rocker switch (if equipped) to ON or RUN.

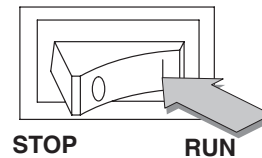

7. Insert key and turn to START.
8. Allow engine to warm up.

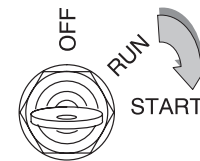

CAUTION

Use short starting cycles (5 seconds, wait one minute between cycles). Follow equipment manufacturer's recommendations for charging battery.

Note: Choke equipped: In warm weather temperatures, move choke control lever toward RUN slowly over several seconds, in cold weather allow engine to run smoothly before each change. Operate with choke in RUN.

Stopping

1. **REWIND (MANUAL) STARTER:** Move throttle control (if equipped) to SLOW and then STOP position.
2. **ELECTRIC (KEY) STARTER:** Move throttle lever (if equipped) to SLOW.

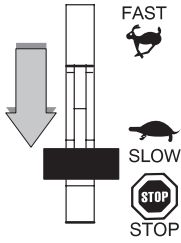

3. **ELECTRIC (KEY) STARTER:** Turn key to OFF. Remove key and store out of reach of children.

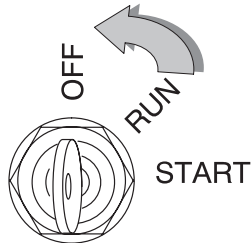

4. Push rocker switch (if equipped) to STOP.

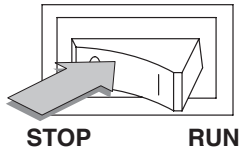

5. Close fuel shut-off valve (if equipped).

Note: When engine is transported, close fuel shut-off valve (if equipped) to prevent leakage.

	WARNING <ul style="list-style-type: none">• Do not stop engine by moving choke control to CHOKE. Backfire, fire or engine damage could occur.
---	--



Need Assistance?

Go to www.briggsandstratton.com or call 1-800-233-3723

Troubleshooting

Starter Handle will Not Pull

- Place equipment on flat level surface.
- Remove all external equipment/engine loads before starting engine.
- Direct coupled equipment components such as, but not limited to, blades, impellers, pulleys, sprockets, etc., must be securely attached.

	WARNING
	<p>Rapid retraction of starter cord (kickback) will pull hand and arm toward engine faster than you can let go.</p> <p>Broken bones, fractures, bruises or sprains could result.</p>

- When starting engine, pull cord slowly until resistance is felt, then pull rapidly.

Engine will Not Start

Out of Fuel

- Add fuel to tank.



Engine Flooded

- **Gasoline engine:** Set choke (if equipped) to OPEN/RUN position, and continue to pull starter handle.

Spark Plug Fouling

- Check and ensure the spark plug is clean. Check the gap with a feeler gauge and reset to .76 mm or .030 in. if necessary.
- If the electrode is burned or worn, replace spark plug with new spark plug.

CAUTION
<p>This engine is shipped from Briggs & Stratton without oil. If you start the engine without oil, the engine will be damaged beyond repair and will not be covered under warranty.</p>

 	WARNING
	<ul style="list-style-type: none">• Ensure fuel cap is in place before starting engine• Turn engine OFF and let engine cool at least 2 minutes before removing fuel cap.• Check fuel lines, tank, cap, and fittings frequently for cracks or leaks. Replace if necessary.• Do not crank engine with spark plug removed.

Engine is Smoking or Running Rough

Engine may have been tipped during transport.

- Check for fouled spark plug.
- Check air cleaner filter for oil saturation. Squeeze pre-cleaner in clean, absorbant cloth to remove ALL EXCESS oil. If air cleaner is saturated, replace with new cartridge.

CAUTION
<p>If engine is tipped to transport equipment, to remove debris, to drain oil, etc., keep the spark plug side of engine up.</p>

Maintenance

Regular maintenance will improve the performance and extend the life of the engine. See any Authorized Briggs & Stratton Dealer for service. **Use only genuine Briggs & Stratton parts. Other parts may not perform as well, may damage the engine, and may result in injury.** In addition, use of other parts may void your warranty.

Emission Control

Maintenance, replacement or repair of the emission control devices and systems may be performed by any nonroad engine repair establishment or individual. However, to obtain no charge repairs under the terms and provisions of the Briggs & Stratton warranty statement, any service or emission control part repair or replacement must be performed by a factory authorized dealer.

CAUTION

All the components used to build this engine assembly must remain in place for the proper operation of this engine.

! WARNING



Unintentional sparking can result in fire or electric shock.

Fire or explosion can cause severe burns or death.

Unintentional start-up can result in entanglement, traumatic amputation, or laceration.



Before performing maintenance or repairs:

- Disconnect spark plug wire and keep it away from spark plug.
- Disconnect battery at negative terminal (only engines with electric start).
- Use only correct tools.
- Do not strike the flywheel with a hammer or hard object because the flywheel may later shatter during operation.
- Do not tamper with governor spring, links or other parts to increase engine speed.

When testing for spark:

- Use approved spark plug tester.
- Do not check for spark with spark plug removed.

Follow the instructions and schedules indicated below.

Task	Every 8 Hours or Daily	25 Hours	50 Hours	100 Hours	100 – 400 Hours
Check Oil Level 					
Service Air Cleaner Pre-Cleaner*					
Inspect Spark Arrester (if equipped)					
Change Oil ** 					
Change Oil Filter (if equipped)					
Service Air Cleaner Cartridge*					
Clean Oil Cooler (if equipped)*					
Clean Cooling System*					
Check Valve Clearance on LPG/NG Engines					
Clean/Replace Spark Plugs 					
Clean/Replace In-line Fuel Filter (if equipped)					
Check Valve Clearance					

* Clean more often under dusty conditions or when airborne debris is present. Replace air cleaner, if very dirty.

** **Change oil after first 5 to 8 hours of use**, then every 100 hours. Change oil every 50 hours when operating the engine under heavy load or in high temperatures.

Changing Oil

Change oil after first 5 to 8 hours of use, then every 100 hours. Change oil every 50 hours when operating the engine under heavy load or in high temperatures.

1. Place engine level.
2. Disconnect spark plug wire and keep it away from spark plug. Disconnect battery (if equipped with electric starter) at negative terminal.
3. With engine OFF but still warm remove oil drain plug and drain oil into appropriate receptacle.



Typical
drain plug

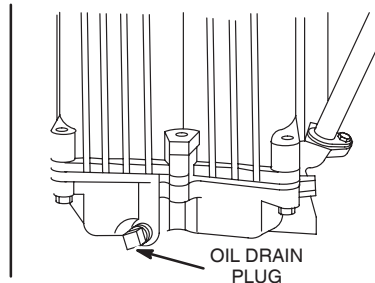

4. Reinstall drain plug. Remove dipstick.
5. **OIL FILLING PROCEDURE:** Add 1 quart (32 ounces or 1 liter). Start and run engine at idle for 30 seconds. Shut engine off and wait 30 seconds. Then add more oil slowly to bring level to FULL mark on dipstick. **Do not overfill.**

Note: Engine holds approximately 1-1/2 quarts (48 ounces or 1.4 liters) when changing oil and filter.

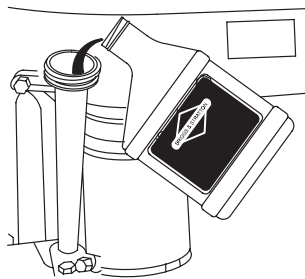

6. Replace dipstick.



WARNING

- Disconnect spark plug wire and keep it away from spark plug.

Changing Oil Filter (if equipped)

Change oil filter after every 100 hours or every season.

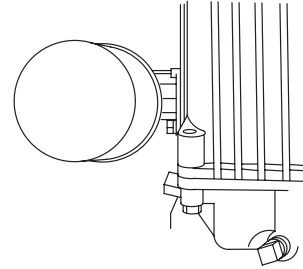

1. Drain engine oil and remove oil filter.
2. Before installing new filter, lightly oil filter gasket with fresh, clean oil.
3. Screw filter on by hand until gasket contacts oil filter adapter. Tighten 1/2 to 3/4 turn more.
4. Add fresh oil. Fill to FULL line on dipstick.
5. Start and run engine at idle to check for leaks.
6. Stop engine. Re-check oil level. Add oil if required.

CAUTION

Used oil is a hazardous waste product. Dispose of used oil properly. Do not discard with household waste. Check with your local authorities, service center, or dealer for safe disposal/recycling facilities.

Oil Pressure

If oil pressure drops below 1-4 psi (0.1-0.2 kg/cm²), an oil pressure switch (if engine is equipped) will either activate a warning device or stop the engine. Check oil level with dipstick. If oil level is between ADD and FULL mark on dipstick **do not try to restart engine**. Contact an authorized Briggs & Stratton Service Dealer. **Do not operate engine until oil pressure is corrected.**

If oil level is below ADD mark on dipstick, add oil to bring level to FULL mark. Restart engine and check oil pressure. If pressure is normal, continue to operate engine.

Note: Oil pressure gauge, if engine is equipped, is supplied by the manufacturer of equipment.

Air Cleaner

All engines have a round air cleaner cartridge. In addition, some engines have a pre-cleaner.

Pre-cleaner

To clean pre-cleaner (if equipped), separate it from cartridge and wash in liquid detergent and water. Squeeze dry in a clean cloth.

Dual element air cleaner

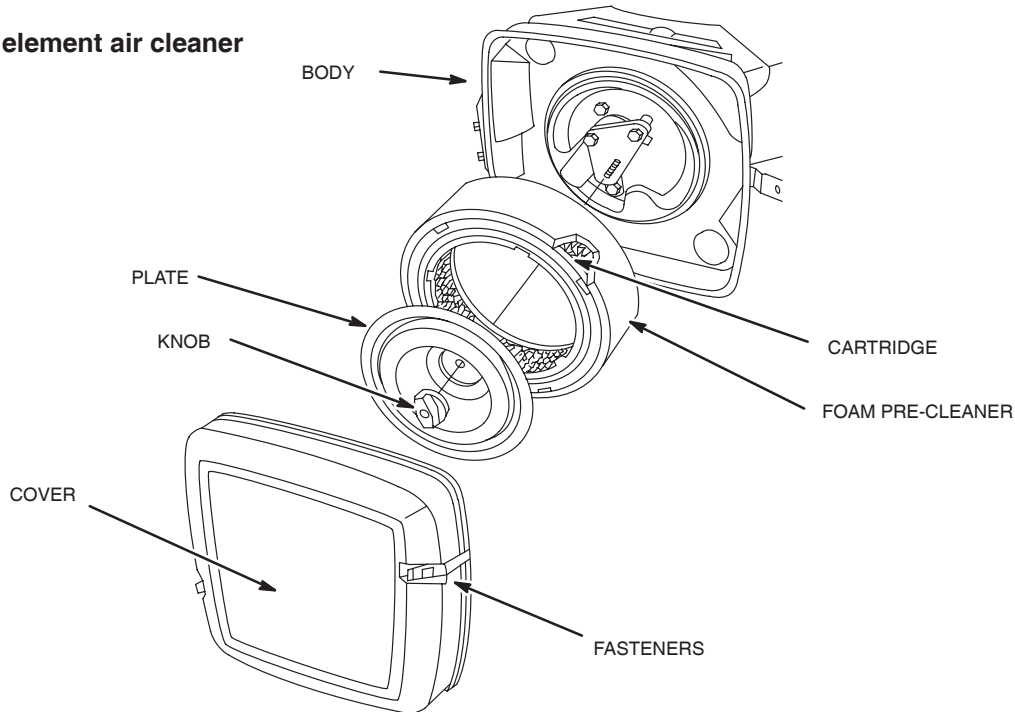

Removing and Installing Air Cleaner

1. Unhook clips on both sides of cover and remove cover.
2. Remove knob and plate. Carefully remove air cleaner assembly to prevent debris from entering carburetor.
3. Reassemble clean (or new) pre-cleaner on clean (or new) cartridge.
4. Reinstall air cleaner assembly, plate and knob in body.
5. Replace cover and reattach clips to body.

WARNING

Ensure air cleaner, retainer, and cover are properly installed before starting engine.

CAUTION

Do not use pressurized air or solvents to clean cartridge. Pressurized air can damage cartridge; solvents will dissolve cartridge.

Spark Plug

Check the spark plug every 100 hours. Replace the spark plug if upon inspection the electrode ① is burned or worn. Ensure the spark plug is clean. Check the gap ② with a wire gauge ③ and reset to .76 mm or 0.030 in. if necessary.

Note: In some areas, local law requires using resistor spark plug to suppress ignition signals. If this engine was originally equipped with resistor spark plug, use same type for replacement.

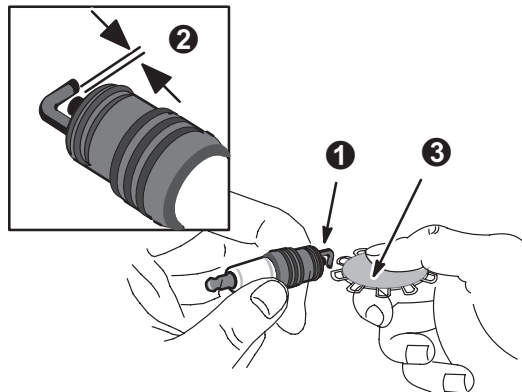

Cleaning Debris

Daily or before every use, clean accumulated debris from engine. Keep linkage, springs and controls clean. Keep area behind and around muffler free of any combustible debris.



WARNING

- Engine parts should be kept clean to reduce the risk of overheating and ignition of accumulated debris.

Rotating Screen

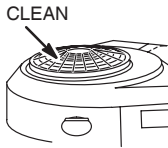

Finger Guard

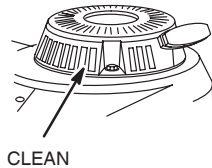

Linkage, Springs and Controls

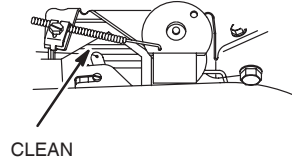

Muffler and Spark Arrester

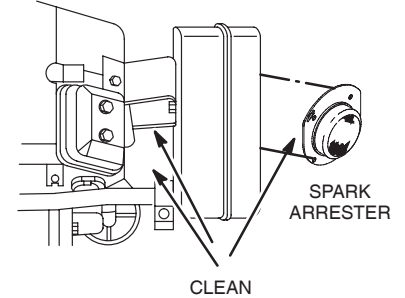

CAUTION

Do not use water to clean engine parts. Water could contaminate fuel system. Use a brush or dry cloth.

Fuel System

Replacing Fuel Filter (if equipped)

Drain Fuel tank or close fuel shut-off valve before replacing fuel filter. Otherwise, fuel can leak out creating a fire/explosion hazard.



WARNING

- Replacement parts for fuel system and muffler (cap, hoses, tanks, filters, etc.) must be the original parts, and installed in the same position as the original parts, otherwise fire can occur.

Muffler

If muffler is equipped with spark arrester screen, remove screen for inspection. Replace screen if damaged or plugged.

Oil Cooler (if equipped)

Clean oil cooler of all debris and chaff.

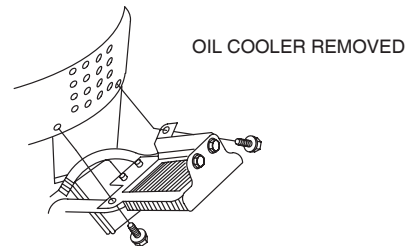

Air Cooling System

Debris may clog the engine's air cooling system. Remove blower housing and clean area shown to prevent overheating and engine damage.

Valve Clearance

Gasoline Engines: Check valve clearance yearly.

LPG/NG Engines: Valve clearance must be checked after every 100 hours of operation. Adjust if necessary.

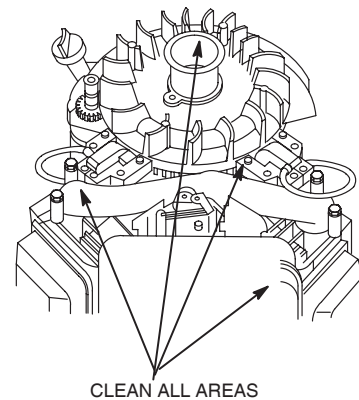

Specifications

We recommend that you use an authorized Briggs & Stratton Service Dealer for all maintenance and service of the engine and engine parts. Use only genuine Briggs & Stratton parts.

In the state of California, Model 290000, 300000, 350000 and 380000 engines are certified by the California Air Resources Board to meet emissions standards for 250 hours. Such certification does not grant the purchaser, owner or operator of this engine any additional warranties with respect to the performance or operational life of this engine. This engine is warranted solely according to the product and emissions warranties stated elsewhere in this manual.

Model 290000 and 300000

Bore 2.68 in. (68 mm)
 Stroke 2.6 in. (66 mm)
 Displacement 29.3 cu. in. (480 cc)

Model 350000

Bore 2.83 in. (72 mm)
 Stroke 2.76 in. (70 mm)
 Displacement 34.7 cu. in. (570 cc)

Model 380000

Bore 2.97 in. (75.5 mm)
 Stroke 2.76 in. (70 mm)
 Displacement 38.2 cu. in. (627 cc)

Tune-up Specifications

Armature air gap .. 0.008 – 0.012 in. (0.20 – 0.30 mm)
 Spark plug gap 0.030 in. (0.76 mm)
 Valve clearance with valve springs installed and piston 1/4 in. (6 mm) past top dead center (check when engine is cold). See Repair Manual P/N 272144.
 Intake 0.004 – 0.006 in. (0.10 – 0.15 mm)
 Exhaust 0.004 – 0.006 in. (0.10 – 0.15mm)

Note: For practical operation, the horsepower loading should not exceed 85% of rated horsepower. Engine power will decrease 3-1/2% for each 1,000 feet (300 meters) above sea level and 1% for each 10° F (5.6° C) above 77° F (25° C). It will operate satisfactorily at an angle up to 15°.

Model, Type and Code Number

To get replacement parts or technical assistance in the future write your engine Model, Type and Code number along with the date of purchase here. These numbers are located on your engine. For the location, see page 3, **Engine Features**.

Model

--	--	--	--	--	--	--	--

Type

--	--	--	--	--	--	--	--

Code

--	--	--	--	--	--	--	--	--	--	--	--

Technical Information

Engine Power Rating Information

The gross power rating for individual gas engine models is labeled in accordance with SAE (Society of Automotive Engineers) code J1940 (Small Engine Power & Torque Rating Procedure), and rating performance has been obtained and corrected in accordance with SAE J1995 (Revision 2002-05). Actual gross engine power will be lower and is affected by, among other things, ambient operating conditions and engine-to-engine variability. Given both the wide array of products on which engines are placed and the variety of environmental issues applicable to operating the equipment, the gas engine will not develop the rated gross power when used in a given piece of power equipment (actual “on-site” or net horsepower). This difference is due to a variety of factors including, but not limited to, accessories (air cleaner, exhaust, charging, cooling, carburetor, fuel pump, etc.), application limitations, ambient operating conditions (temperature, humidity, altitude), and engine-to-engine variability. Due to manufacturing and capacity limitations, Briggs & Stratton may substitute an engine of higher rated power for this Series engine.

Emission Information

Engines that are certified to meet the California Air Resources Board (CARB) Tier 2 Emission Standards must display information regarding the Emissions Durability Period and the Air Index. Briggs & Stratton makes this information available to the consumer on our emission labels. The engine emission label will indicate certification information.

The **Emissions Durability Period** describes the number of hours of actual running time for which the engine is certified to be emissions compliant, assuming proper maintenance in accordance with the Operating & Maintenance Instructions. The following categories are used:

Moderate:

Engine is certified to be emission compliant for 125 hours of actual engine running time.

Intermediate:

Engine is certified to be emission compliant for 250 hours of actual engine running time.

Extended:

Engine is certified to be emission compliant for 500 hours of actual engine running time. For example, a typical walk-behind lawn mower is used 20 to 25 hours per year. Therefore, the **Emissions Durability Period** of an engine with an **intermediate** rating would equate to 10 to 12 years.

Certain Briggs & Stratton engines will be certified to meet the United States Environmental Protection Agency (USEPA) Phase 2 emission standards. For Phase 2 certified engines, the Emissions Compliance Period referred to on the Emissions Compliance label indicates the number of operating hours for which the engine has been shown to meet Federal emission requirements.

For engines less than 225 cc displacement.

Category C = 125 hours
 Category B = 250 hours
 Category A = 500 hours

For engines of 225 cc or more displacement.

Category C = 250 hours
 Category B = 500 hours
 Category A = 1000 hours.

Storage

- Engines stored over 30 days need to be protected or drained of fuel to prevent gum from forming in fuel system or on essential carburetor parts.
 - If fuel tank contains oxygenated or reformulated gasoline** (gasoline blended with an alcohol or an ether), run engine until it stops from lack of fuel.
 - If fuel tank contains gasoline**, either run engine until it stops from lack of fuel, or add a gasoline additive to the gas in tank.
- While engine is still warm, change oil.
- Remove spark plug and pour about 1/2 oz (15ml) of engine oil into cylinder. Replace spark plug and crank slowly to distribute oil.
- Clean dirt and chaff from cylinder, cylinder head fins, blower housing and rotating screen areas.
- Store in a clean, dry area. Do not store in same area as a stove, furnace, water heater, or other appliance that uses a pilot light or has a device that can create a spark.

Service

See an Authorized Briggs & Stratton Service Dealer for all your engine service needs. Each one carries a stock of Genuine Briggs & Stratton Parts and is equipped with special service tools. Trained mechanics assure expert repair service on all Briggs & Stratton engines. Only dealers advertising as "Authorized Briggs & Stratton" are required to meet Briggs & Stratton standards.

When you purchase equipment powered by Briggs & Stratton, you are assured of highly skilled, reliable engine service at more than 30,000 Authorized Service Dealers worldwide, including more than 6,000 Master Service Technicians. Look for these signs wherever Briggs & Stratton service is offered.



You may find the nearest Authorized Service Dealer in our dealer locator map at

www.briggsandstratton.com, or by calling 1-800-233-3723



Need Assistance?

Go to www.briggsandstratton.com or call 1-800-233-3723



WARNING

When storing fuel or equipment with fuel in tank:

- Store away from furnaces, stoves, water heaters, or other appliances that have a pilot light or other ignition source because they can ignite vapors.

When Transporting Equipment:

- Gasoline Engine:** Transport with fuel tank EMPTY or with fuel shut-off valve OFF.
- Liquid Petroleum Gas (LPG) /Natural Gas Engine:** Transport with fuel cylinder empty and valve closed or tank disconnected.

PARTIAL LIST OF GENUINE BRIGGS & STRATTON PARTS

<u>PART</u>	<u>PART NO.</u>
Air Cleaner Cartridge	394018
Air Cleaner Pre-Cleaner	272490
Air Cleaner Pre-cleaner and Cartridge	5050
Air Cleaner Cartridge (380700)	692519
Air Cleaner Pre-cleaner (380700)	692520
Oil	100005 -OR- 100028
Oil Filter (3-1/2 in. long)	491056
Oil Filter (2-1/4 in. long)	492932 -OR- 5049
Fuel Filter (with fuel pump)	493629
Fuel Filter (without fuel pump)	298090 -OR- 5018
Gas Additive	5041
Resistor Spark Plug	491055
Resistor Spark Plug	496018
Long Life Platinum Spark Plug (used on most OHV engines)	5066
Spark Plug Wrench	19374
Spark Tester	19368
Oil Pump Kit (uses standard electric drill to remove oil from engine quickly)	5056

An illustrated shop manual includes common specifications and detailed information covering adjustment, tune-up and repair of Briggs & Stratton single cylinder, 4 cycle engines. It is available for purchase from an Authorized Briggs & Stratton Service Dealer or you can order it from

www.briggsandstratton.com.

Warranty Information

Briggs & Stratton Corporation (B&S), the California Air Resources Board (CARB) and the United States Environmental Protection Agency (U.S. EPA) Emissions Control System Warranty Statement (Owner's Defect Warranty Rights and Obligations)

The California Air Resources Board (CARB), U.S. EPA and B&S are pleased to explain the Emissions Control System Warranty on your small off-road engine (SORE). In California, new small off-road engines model year 2006 and later must be designed, built and equipped to meet the State's stringent anti-smog standards.

Elsewhere in the United States, new non-road, spark-ignition engines certified for model year 1997 and later must meet similar standards set forth by the U.S. EPA. B&S must warrant the emissions control system on your engine for the

periods of time listed below, provided there has been no abuse, neglect or improper maintenance of your small off-road engine.

Your emissions control system includes parts such as the carburetor, air cleaner, ignition system, fuel line, muffler and catalytic converter. Also included may be connectors and other emissions related assemblies.

Where a warrantable condition exists, B&S will repair your small off-road engine at no cost to you including diagnosis, parts and labor.

Briggs & Stratton Emissions Control Defects Warranty Coverage

Small off-road engines are warranted relative to emissions control parts defects for a period of two years, subject to provisions set forth below. If any covered part on your engine is defective, the part will be repaired or replaced by B&S.

Owner's Warranty Responsibilities

As the small off-road engine owner, you are responsible for the performance of the required maintenance listed in your Operating and Maintenance Instructions. B&S recommends that you retain all your receipts covering maintenance on your small off-road engine, but B&S cannot deny warranty solely for the lack of receipts or for your failure to ensure the performance of all scheduled maintenance.

As the small off-road engine owner, you should however be aware that B&S may deny your warranty coverage if your small off-road engine or a part has failed due to abuse, neglect, improper maintenance or unapproved modifications.

You are responsible for presenting your small off-road engine to an Authorized B&S Service Dealer as soon as a problem exists.

The undisputed warranty repairs should be completed in a reasonable amount of time, not to exceed 30 days.

If you have any questions regarding your warranty rights and responsibilities, you should contact a B&S Service Representative at 1-414-259-5262.

The emissions warranty is a defects warranty. Defects are judged on normal engine performance. The warranty is not related to an in-use emissions test.

Briggs & Stratton Emissions Control Defects Warranty Provisions

The following are specific provisions relative to your Emissions Control Defects Warranty Coverage. It is in addition to the B&S engine warranty for non-regulated engines found in the Operating and Maintenance Instructions.

1. Warranted Parts

Coverage under this warranty extends only to the parts listed below (the emissions control systems parts) to the extent these parts were present on the engine purchased.

a. Fuel Metering System

- Cold start enrichment system
- Carburetor and internal parts
- Fuel pump
- Fuel line, fuel line fittings, clamps
- Fuel tank, cap and tether
- Carbon canister

b. Air Induction System

- Air cleaner
- Intake manifold
- Purge and vent line

c. Ignition System

- Spark plug(s)
- Magneto ignition system

d. Catalyst System

- Catalytic converter
- Exhaust manifold
- Air injection system, Pulse valve

e. Miscellaneous Items

- Vacuum, temperature, position, time sensitive valves and switches
- Connectors and assemblies

2. Length of Coverage

B&S warrants to the initial owner and each subsequent purchaser that the Warranted Parts shall be free from defects in materials and workmanship which caused the failure of the Warranted Parts for a period of two years from the date the engine is delivered to a retail purchaser.

3. No Charge

Repair or replacement of any Warranted Part will be

performed at no charge to the owner, including diagnostic labor which leads to the determination that a Warranted Part is defective, if the diagnostic work is performed at an Authorized B&S Service Dealer. For emissions warranty service contact your nearest Authorized B&S Service Dealer as listed in the "Yellow Pages" under "Engines, Gasoline," "Gasoline Engines," "Lawn Mowers," or similar category.

4. Claims and Coverage Exclusions

Warranty claims shall be filed in accordance with the provisions of the B&S Engine Warranty Policy. Warranty coverage shall be excluded for failures of Warranted Parts which are not original B&S parts or because of abuse, neglect or improper maintenance as set forth in the B&S Engine Warranty Policy. B&S is not liable to cover failures of Warranted Parts caused by the use of add-on, non-original, or modified parts.

5. Maintenance

Any Warranted Part which is not scheduled for replacement as required maintenance or which is scheduled only for regular inspection to the effect of "repair or replace as necessary" shall be warranted as to defects for the warranty period. Any Warranted Part which is scheduled for replacement as required maintenance shall be warranted as to defects only for the period of time up to the first scheduled replacement for that part. Any replacement part that is equivalent in performance and durability may be used in the performance of any maintenance or repairs. The owner is responsible for the performance of all required maintenance, as defined in the B&S Operating and Maintenance Instructions.

6. Consequential Coverage

Coverage hereunder shall extend to the failure of any engine components caused by the failure of any Warranted Part still under warranty.

ABOUT YOUR ENGINE WARRANTY

Briggs & Stratton welcomes warranty repair and apologizes to you for being inconvenienced. Any Authorized Service Dealer may perform warranty repairs. Most warranty repairs are handled routinely, but sometimes requests for warranty service may not be appropriate. For example, warranty would not apply if engine damage occurred because of misuse, lack of routine maintenance, shipping, handling, warehousing or improper installation. Similarly, warranty is void if the serial number of the engine has been removed or the engine has been altered or modified.

If a customer differs with the decision of the Service Dealer, an investigation will be made to determine whether the warranty applies. Ask the Service Dealer to submit all supporting facts to his Distributor or the Factory for review. If the Distributor or the Factory decides that the claim is justified, the customer will be fully reimbursed for those items that are defective. To avoid misunderstanding which might occur between the customer and the Dealer, listed below are some of the causes of engine failure that the warranty does not cover.

Normal wear:

Engines, like all mechanical devices, need periodic parts service and replacement to perform well. Warranty will not cover repair when normal use has exhausted the life of a part or an engine.

Improper maintenance:

The life of an engine depends upon the conditions under which it operates, and the care it receives. Some applications, such as tillers, pumps and rotary mowers, are very often used in dusty or dirty conditions, which can cause what appears to be premature wear. Such wear, when caused by dirt, dust, spark plug cleaning grit, or other abrasive material that has entered the engine because of improper maintenance, is not covered by warranty.

This warranty covers engine related defective material and/or workmanship only, and not replacement or refund of the equipment to which the engine may be mounted. Nor does the warranty extend to repairs required because of:

1. PROBLEMS CAUSED BY PARTS THAT ARE NOT ORIGINAL BRIGGS & STRATTON PARTS.
2. Equipment controls or installations that prevent starting, cause unsatisfactory engine performance, or shorten engine life. (Contact equipment manufacturer.)
3. Leaking carburetors, clogged fuel pipes, sticking valves, or other damage, caused by using contaminated or stale fuel. (Use clean, fresh, lead-free gasoline and Briggs & Stratton Fuel Stabilizer, Part No. 5041.)
4. Parts which are scored or broken because an engine was operated with insufficient or contaminated lubricating oil, or an incorrect grade of lubricating oil (check oil level daily or after every 8 hours of operation. Refill when necessary and change at recommended intervals.) OIL GARD may not shut down running engine. Engine damage may occur if oil level is not properly maintained. Read Operating & Maintenance Instructions.
5. Repair or adjustment of associated parts or assemblies such as clutches, transmissions, remote controls, etc., which are not manufactured by Briggs & Stratton.
6. Damage or wear to parts caused by dirt, which entered the engine because of improper air cleaner maintenance, re-assembly, or use of a non-original air cleaner element or cartridge. (At recommended intervals, clean and re-oil the Oil-Foam element or the foam pre-cleaner, and replace the cartridge.) Read Operating & Maintenance Instructions.
7. Parts damaged by over-speeding, or overheating caused by grass, debris, or dirt, which plugs or clogs the cooling fins, or flywheel area, or damage caused by operating the engine in a confined area without sufficient ventilation. (Clean fins on the cylinder, cylinder head and flywheel at recommended intervals.) Read Operating & Maintenance Instructions.
8. Engine or equipment parts broken by excessive vibration caused by a loose engine mounting, loose cutter blades, unbalanced blades or loose or unbalanced impellers, improper attachment of equipment to engine crankshaft, over-speeding or other abuse in operation.
9. A bent or broken crankshaft, caused by striking a solid object with the cutter blade of a rotary lawn mower, or excessive v-belt tightness.
10. Routine tune-up or adjustment of the engine.
11. Engine or engine component failure, i.e., combustion chamber, valves, valve seats, valve guides, or burned starter motor windings, caused by the use of alternate fuels such as, liquified petroleum, natural gas, altered gasolines, etc.

Warranty is available only through service dealers which have been authorized by Briggs & Stratton Corporation. your nearest Authorized Service Dealer is listed in the "Yellow Pages™" of your telephone directory under "Engines, Gasoline" or "Gasoline Engines," "Lawn Mowers," or similar category.

BRIGGS & STRATTON ENGINE OWNER WARRANTY POLICY

Effective September 1, 2006

LIMITED WARRANTY

Briggs & Stratton Corporation will repair or replace, free of charge, any part(s) of the engine that is defective in material or workmanship or both. Transportation charges on parts submitted for repair or replacement under this warranty must be borne by purchaser. This warranty is effective for and is subject to the time periods and conditions stated below. For warranty service, find the nearest Authorized Service Dealer in our dealer locator map at www.briggsandstratton.com, or by calling 1-800-233-3723, or as listed in the 'Yellow Pages™'.

THERE IS NO OTHER EXPRESS WARRANTY. IMPLIED WARRANTIES, INCLUDING THOSE OF MERCHANTABILITY AND FITNESS FOR A PARTICULAR PURPOSE, ARE LIMITED TO ONE YEAR FROM PURCHASE, OR TO THE EXTENT PERMITTED BY LAW ANY AND ALL IMPLIED WARRANTIES ARE EXCLUDED. LIABILITY FOR INCIDENTAL OR CONSEQUENTIAL DAMAGES ARE EXCLUDED TO THE EXTENT EXCLUSION IS PERMITTED BY LAW. Some states or countries do not allow limitations on how long an implied warranty lasts, and some states or countries do not allow the exclusion or limitation of incidental or consequential damages, so the above limitation and exclusion may not apply to you. This warranty gives you specific legal rights and you may also have other rights which vary from state to state and country to country.

WARRANTY TERMS **

Brand/Product Type	Consumer Use	Commercial Use
Vanguard™	2 years	2 years
Extended Life Series™	2 years	1 year
I/C®, or Intek I/C®, Intek Pro™	2 years	180 days
Kerosene Fuel Operated Engines	1 year	90 days
All Other Briggs & Stratton Engines	2 years	90 days

** Engines used on Home Standby Generator applications are warranted under consumer use only. This warranty does not apply to engines on equipment used for prime power in place of a utility. **Engines used in competitive racing or on commercial or rental tracks are not warranted.**

The warranty period begins on the date of purchase by the first retail consumer or commercial end user, and continues for the period of time stated in the table above. "Consumer use" means personal residential household use by a retail consumer. "Commercial use" means all other uses, including use for commercial, income producing or rental purposes. Once an engine has experienced commercial use, it shall thereafter be considered as a commercial use engine for purposes of this warranty.

NO WARRANTY REGISTRATION IS NECESSARY TO OBTAIN WARRANTY ON BRIGGS & STRATTON PRODUCTS. SAVE YOUR PROOF OF PURCHASE RECEIPT. IF YOU DO NOT PROVIDE PROOF OF THE INITIAL PURCHASE DATE AT THE TIME WARRANTY SERVICE IS REQUESTED, THE MANUFACTURING DATE OF THE PRODUCT WILL BE USED TO DETERMINE THE WARRANTY PERIOD.

Briggs & Stratton Engines Are Made Under One Or More Of The Following Patents: Design D-247,177 (Other Patents Pending)

6,691,683	6,520,141	6,325,036	6,145,487	6,012,420	5,803,035	5,548,955	5,243,878	5,138,996	4,875,448	D 476,629
6,647,942	6,495,267	6,311,663	6,142,257	5,992,367	5,765,713	5,546,901	5,235,943	5,086,890	4,819,593	D 457,891
6,622,683	6,494,175	6,284,123	6,135,426	5,904,124	5,732,555	5,445,014	5,234,038	5,070,829	4,720,638	D 368,187
6,615,787	6,472,790	6,263,852	6,116,212	5,894,715	5,645,025	5,503,125	5,228,487	5,058,544	4,719,682	D 375,963
6,617,725	6,460,502	6,260,529	6,105,548	5,887,678	5,642,701	5,501,203	5,197,426	5,040,644	4,633,556	D 309,457
6,603,227	6,456,515	6,242,828	6,347,614	5,852,951	5,628,352	5,497,679	5,197,425	5,009,208	4,630,498	D 372,871
6,595,897	6,382,166	6,239,709	6,082,323	5,843,345	5,619,845	5,320,795	5,197,422	4,996,956	4,522,080	D 361,771
6,595,176	6,369,532	6,237,555	6,077,063	5,823,153	5,606,948	5,301,643	5,191,864	4,977,879	4,520,288	D 356,951
6,584,964	6,356,003	6,230,678	6,064,027	5,819,513	5,606,851	5,271,363	5,188,069	4,977,877	4,512,499	D 309,457
6,557,833	6,349,688	6,213,083	6,040,767	5,813,384	5,605,130	5,269,713	5,186,142	4,971,219	4,453,507	D 308,872
6,542,074	6,347,614	6,202,616	6,014,808	5,809,958	5,497,679	5,265,700	5,150,674	4,895,119	4,430,984	D 308,871



THE POWER WITHIN™